

LADY



 **ravioli** *SpA*



ISO 9001: 2000
9105.RAVI

Pendant Stations LADY Series

Pendant Stations

LADY Series - LA type single-row

Main Features

The new LADY series single-row push-button stations for auxiliary circuits are the result of a blend of Ravioli's long experience in the field, detailed studies in ergonomics, and the use of innovative, modern design and materials, in compliance with the best technology available today.

In designing the product particular attention was paid both to easy handling features and to the technical aspects, in order to ensure usage also in heavy-duty circumstances.

All the materials, which come into direct contact with the environment, are resistant to atmospheric agents, oils, temperature changes and are shockproof. The rubber gaskets ensure optimal protection against dust and liquids.

The optimised internal space allows to make all connections easily and quickly. Bridge connections have been projected in order to reduce cabling time and are available upon request.

LADY push-button station is offered in 6 different sizes, ranging from 2 to 12 buttons devices and various controls and switches can be mounted on each type.

LAP versions for bridge cranes and hoists and LAE for building cranes are available. The emergency stop push-button has been designed in according to EN 418 regulations. The NC contacts feature guaranteed opening (EN 60947-5-1) and can be supplied also in the 2NC increased safety version.

All buttons are marked with international symbols.

The switches have self-cleaning sliding contacts in silver alloy.



TECHNICAL FEATURES

Compliance with EEC Directives	2006/95 CE	93/68 CE	98/37 CE	2004/108 CE
Compliance with rules	EN 60947-1	EN 60947-5-1	EN 60529	
	EN 60204-1	EN 60204-32	EN 418	
Insulation voltage	660 V~			
Test voltage	2500 V~			
Max. operating voltage	400 V~			
Temperature range	Working - 25° C + 70° C			
	Storage - 40° C + 70° C			
Insulation	Class II (double insulation)			
Protection degree	IP 65			
Operating positions	All positions			
Cable entry	2 - 4 buttons: rubber sleeve D. 12-17 mm			
	6 - 12 buttons: rubber sleeve D. 15-20 mm			
Homologation	CE			



The range of pendant stations and joystick controllers is completed by:

Consult our catalogues n. 4 and 6

For Your Safety

Single-row LADY series pendant stations comply with the current safety rules, and in particular:

- 98/37 CE Machine Directive
- 2006/95 CE Low Voltage Directive
- 93/68 CEE Low Voltage Directive
- 2004/108 CE EMC Directive
- EN 60204-32 Lifting Machinery Safety Regulations
- EN 60947-1 Low-voltage switchgear and controlgear
- EN 60947-5-1 Control circuits devices and switching elements

Guaranteed Quality Product

Single-row LADY series pendant stations are guaranteed by our EC Certificate of Conformity, available upon request, in which it is declared that such product was created by RAVIOLI in accordance to defined and recognised Safety Regulations, and in compliance with the quality standards stated in our UNI EN ISO 9001:2000 Quality System Certificate.

Dimensions

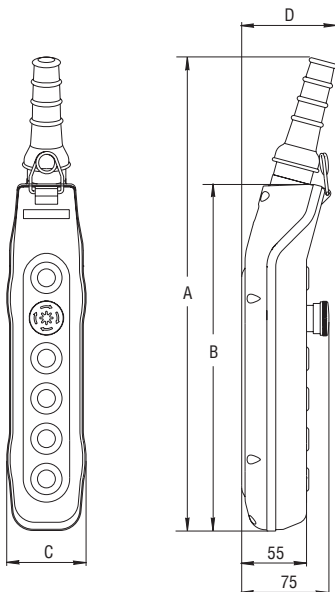

N. Buttons	Dimensions (mm)				Weight (Kg.)
	A	B	C	D	
2	264	166	66	77	0,280
4	336	238	66	77	0,430
6	424	310	71	82	0,590
8	496	382	71	82	0,750
10	568	454	71	82	0,880
12	640	526	71	82	1,040

MK Switching Element

Main Features

The MK push button elements are inside parts of the LADY pendant stations.

Casing is made in self-extinguishing nylon glass.

Double breaking and self-cleaning sliding contact elements are in silver alloy.

Screws and springs in inox steel.

MK elements are supplied as push button station spare parts.

TECHNICAL FEATURES

Compliance with rules	EN 60947-5-1
Insulation voltage	660 V ~
Nominal thermal current	10 A
Mechanical life	3x10 ⁶ operations
Maximum connectable section	2x1,5 mm ² or 1x2,5 mm ²
Terminals	Secured clamping screws

Use limits	AC15	Ve (V)	24	48	120	240	400
		Ie (A)	10	10	6	3	1,9
	DC13	Ve (V)	24	48	125	250	
		Ie (A)	5	5	2,2	1,1	

Homologation	CE
--------------	----

Types and Codes

type	1NC	1NO	2NC simult.	2NO simult.	1NO+NC	2NO steps.
cod.	<i>D MK01</i>	<i>D MK10</i>	<i>D MK02</i>	<i>D MK20CC</i>	<i>D MK11</i>	<i>D MK20PR</i>



Two steps

One step

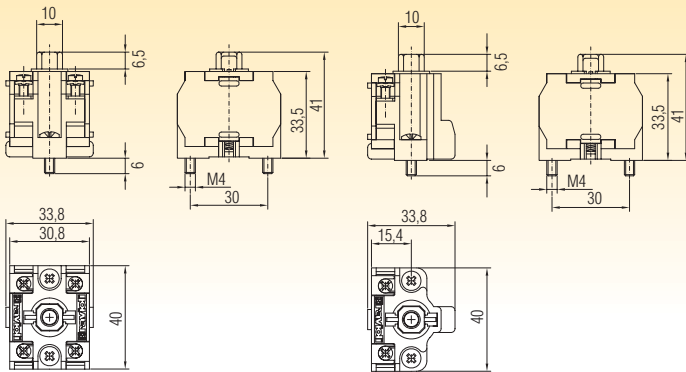

Push buttons with International Symbols

According to FEM 9,941 rules

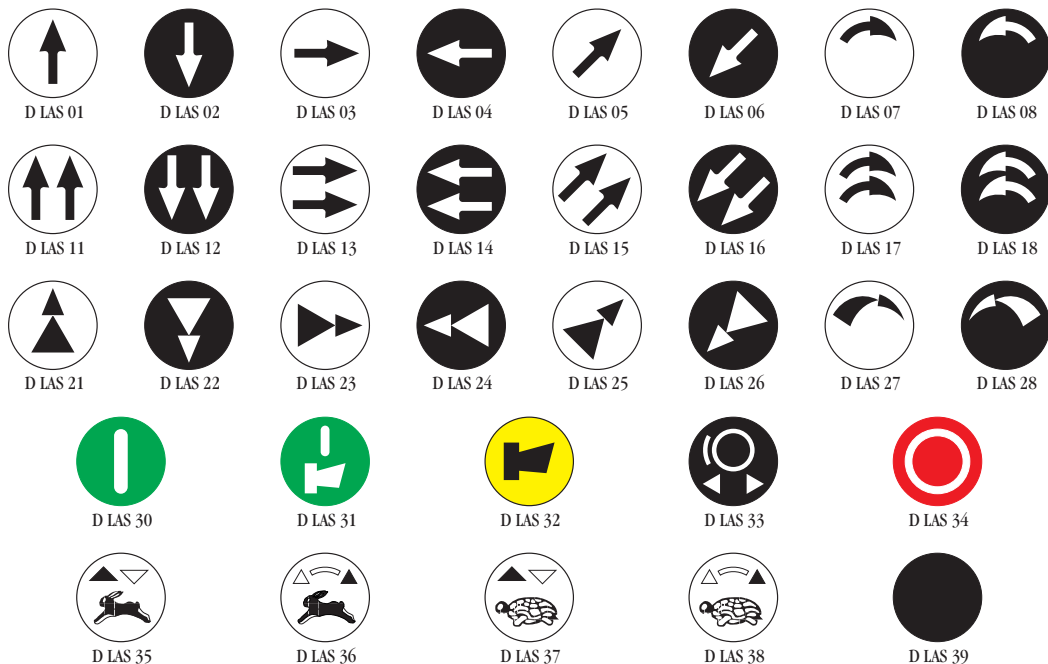

Types and Codes to be used when ordering

Single-row LADY series pendant stations can be produced in LAP versions for bridge cranes and in LAE versions for building cranes.



No. buttons	LAP type Codes	LAE type Codes
2	<i>D LAP2</i>	
3	<i>D LAP3</i>	
4	<i>D LAP4</i>	<i>D LAE4</i>
6	<i>D LAP6</i>	<i>D LAE6</i>
8	<i>D LAP8</i>	<i>D LAE8</i>
10	<i>D LAP10</i>	<i>D LAE10</i>
12	<i>D LAP12</i>	<i>D LAE12</i>

For standard versions : see pages 6 and 7.

Installation and maintenance instructions

INSTALLATION

The push-button stations must be installed by a qualified staff, according to safety law in force (see page 3). Electrical current must be switched off before to effecting the connection.

Internal cabling must be carried out in strict compliance with the electrical drawings of the controlled machine.

After installing, a test of the emergency stop as well as all other buttons operated by the pendant station, must be executed.

Avoid prolonged use of oils and acidic substances during usage, as they may cause damage to the pendant station.

CABLING

Cabling should be carried out as follows:

- remove cover (2) and loosen screws
- remove wire clamp by loosening the screws holding it in place
- assess diameter of available cable and cut rubber sleeve (3) so that, once the cable has been inserted, the device will be perfectly water- and dust-proof.
- tighten wire clamp, ensuring that cable is securely fixed
- carry out cabling procedure
- close pendant station paying attention to correct positioning of rubber gaskets.

INSERTION OF LABELLING

Labelling of the individual buttons may be replaced when cabling has been completed.

MAINTENANCE

In order to ensure perfect working of equipment over time, a programmed periodic maintenance is advised.

All operations must be done by authorised staff and the exclusive use of original spare parts is to be considered mandatory.

Any part showing signs of wear or defects should be replaced even without delay, in order to ensure maximum safety of operation at all times.

In particular, it is necessary to:

- clean push-button station periodically, using non-aggressive products and compressed air on external parts and compressed air only on internal parts
- check that all screws on pack are tightened
- check internal cabling and that connecting terminals are tightly closed
- check that all gaskets and rubber parts are in good working order
- check that casing is in good condition
- check correct working of the equipment by carrying out a series of test manoeuvres

Any alteration of the parts of the push-button station will make the manufacturer's guarantee decline.

RAVIOLI declines any responsibility for damage deriving from incorrect installation or improper use of the product.

Standard Executions

The types of push button pendant stations shown here are standard versions designed for use on the best-known bridge cranes, hoists and building cranes in the world.

A mechanical interlock for opposite movements is mounted as standard.

Thanks to the versatility of assembly, personalised executions are available upon request.

Switching elements on standard versions

Type of control	Switching element	Code
On	1NO	<i>D MK10</i>
Alarm	1NO	<i>D MK10</i>
On/Alarm	2NO simultaneous	<i>D MK20CC</i>
Emergency stop	1NC	<i>D MK01</i>
1 speed movement	1NO	<i>D MK10</i>
2 speeds movement	2NO progressive	<i>D MK20PR</i>

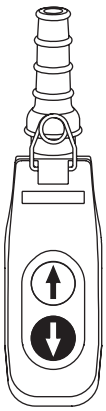

LAP 2A

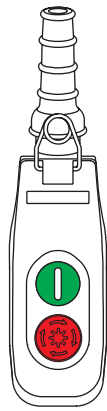

LAP 2B



LAP 3A

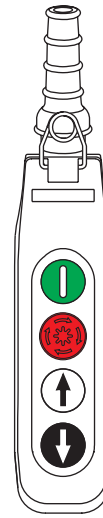

LAP 4A

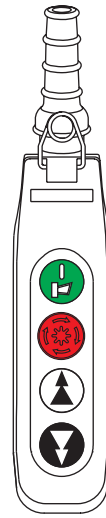

LAP 4B

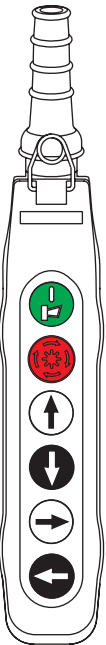

LAP 6A

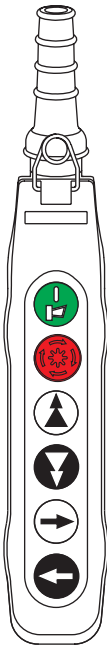

LAP 6B

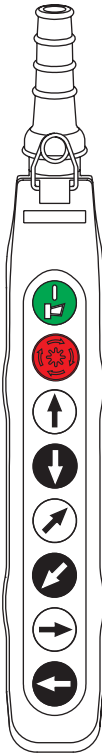

LAP 8A

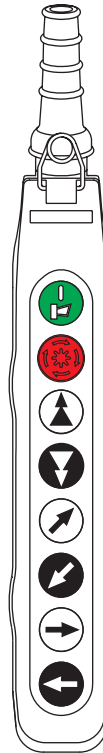

LAP 8B

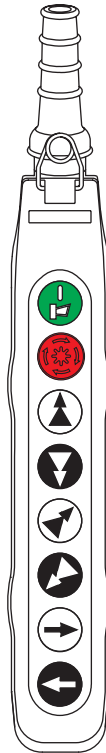

LAP 8C

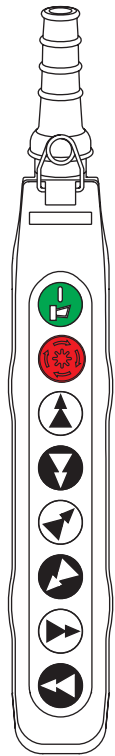

L A P 8D

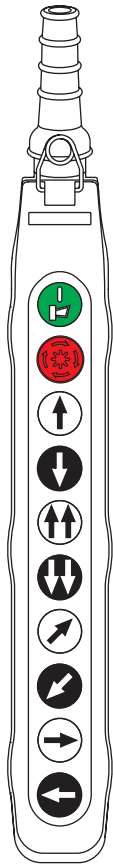

L A P 10A

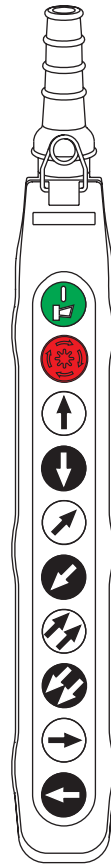

L A P 10B

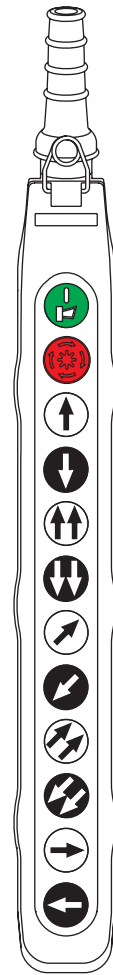

L A P 12A

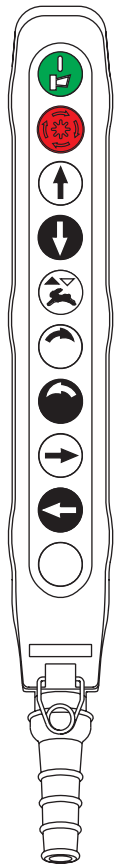

L A E 9A

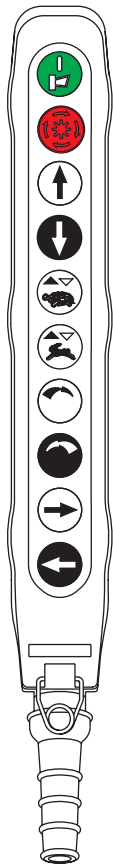

L A E 10A

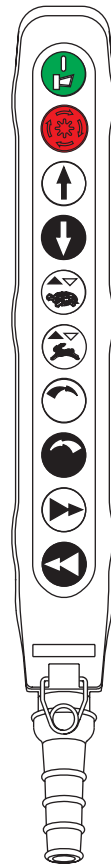

L A E 10B

Available upon request

Make up your own pendant station

Button type Switching element type

Rubber sleeve

_____	<input type="radio"/>	_____
_____	<input type="radio"/>	_____
_____	<input type="radio"/>	_____
_____	<input type="radio"/>	_____
_____	<input type="radio"/>	_____
_____	<input type="radio"/>	_____
_____	<input type="radio"/>	_____
_____	<input type="radio"/>	_____
_____	<input type="radio"/>	_____
_____	<input type="radio"/>	_____

Rubber sleeve

Spare Parts and Fittings

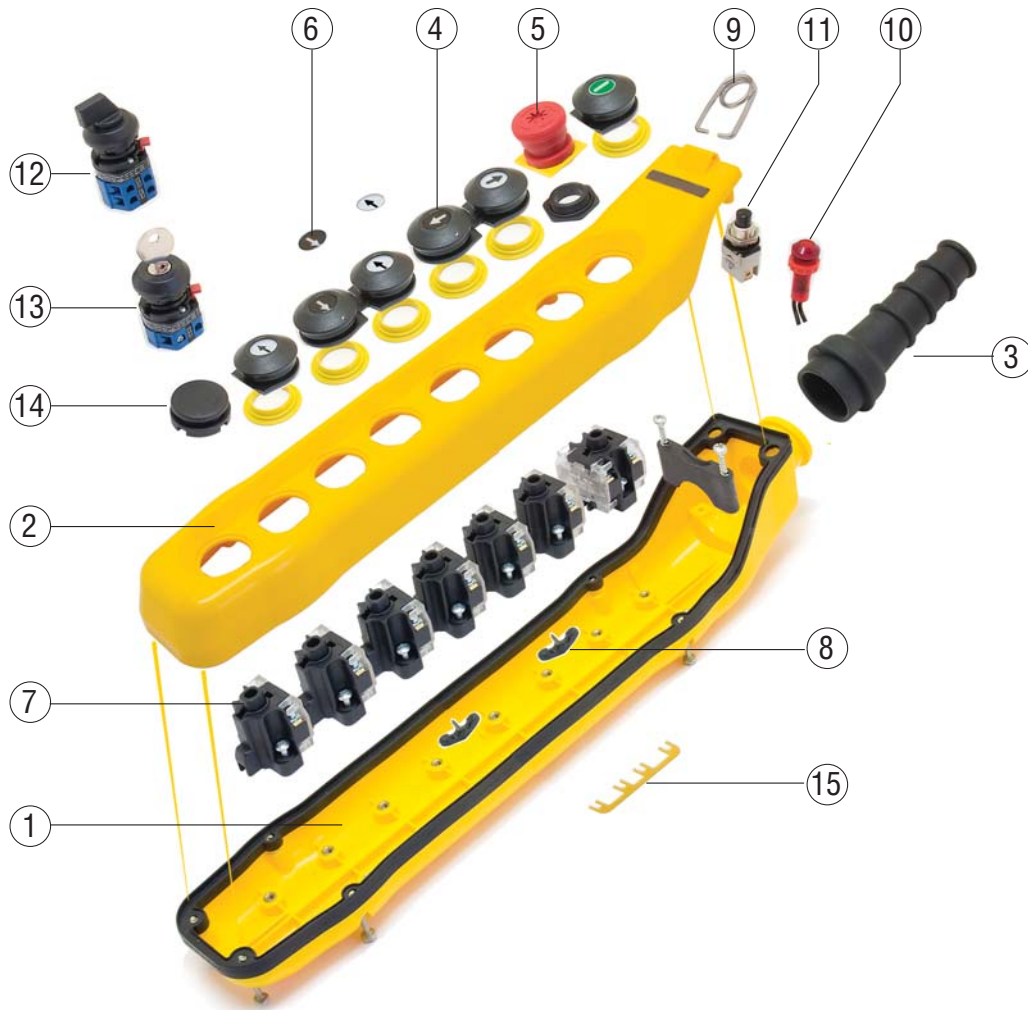

Pos. Code	Description
Spare parts	
1	<i>D LA02FON</i> Bottom for 2 buttons station <i>D LA04FON</i> Bottom for 4 buttons station <i>D LA06FON</i> Bottom for 6 buttons station <i>D LA08FON</i> Bottom for 8 buttons station <i>D LA10FON</i> Bottom for 10 buttons station <i>D LA12FON</i> Bottom for 12 buttons station with rubber gasket string wire clamp screws
2	<i>D LA02COP</i> Cover for 2 buttons station <i>D LA04COP</i> Cover for 4 buttons station <i>D LA06COP</i> Cover for 6 buttons station <i>D LA08COP</i> Cover for 8 buttons station <i>D LA10COP</i> Cover for 10 buttons station <i>D LA12COP</i> Cover for 12 buttons station
3	<i>D LAMC</i> 2-4 buttons pendant station rubber sleeve <i>D LAML</i> 6-12 buttons pendant station rubber sleeve
4	<i>D LAGUA2</i> Rubber gasket for 2 push-buttons with ring
5	<i>D LAEM</i> Mushroom head emergency stop button (without push-button element)
6	<i>D LASXX</i> Buttons with international symbols

Pos. Code	Description
Spare Parts	
7	<i>D MK10</i> 1NO push-button element <i>D MK01</i> 1NC push-button element <i>D MK11</i> 1NO + 1NC push-button element <i>D MK20CC</i> 2NO push-button element (simultaneous) <i>D MK20PR</i> 2NO push-button element (progressive) <i>D MK02CC</i> 2NC push-button element (simultaneous)
8	<i>D PKBLMEC</i> Mechanical interlock
9	<i>D LAGAN</i> Suspension hanger
Fittings	
10	<i>D LAPL</i> Pilot lamp
11	<i>D LABZ</i> 1NO push-button
12	<i>D LALS</i> Lever selector 0-1 <i>D LALS3</i> Lever selector 0-1-2
13	<i>D LAKS</i> Key selector 0-1 <i>D LAKS3</i> Key selector 0-1-2
14	<i>D LACL</i> Closure element with rubber gasket
15	<i>D LACC2SQ</i> 2 pins bridge connection 90° <i>D LACC4</i> 4 pins bridge connection 90°